

Product Family: 2-Terminal High Current Jumper

Part Number Series: D1LPC Series

	Construction: <ul style="list-style-type: none"> • Cu metal foil resistive element • Epoxy-resin overcoat • Non-wrapped terminations • 100% matte tin over Ni terminations • RoHS compliant and Pb free • Inherently Anti-Sulfur 	Features: <ul style="list-style-type: none"> • 0201, 0402, 0603, 0805, and 1206 English case sizes • Max resistance of up to 1mΩ • Max current up to 40 Amps • Low profile • High volume production suitable for commercial and special applications
--	---	--

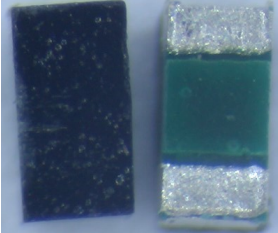

Description:

These high current metal foil jumper chip resistors exhibit excellent performance with a very low height profile. They are useful in many jumper applications where high current withstand and high durability are required.

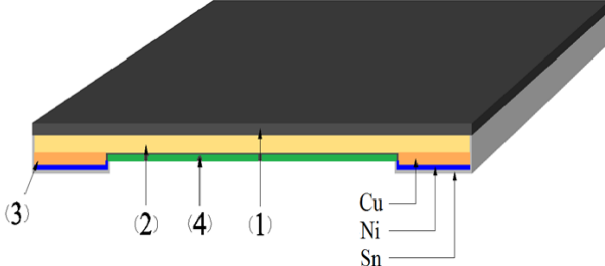
Product Construction:

	<table border="1"> <thead> <tr> <th>Number</th> <th>Description</th> </tr> </thead> <tbody> <tr> <td>1</td> <td>Substrate (glass epoxy)</td> </tr> <tr> <td>2</td> <td>Resistor Element (Cu alloy foil)</td> </tr> <tr> <td>3</td> <td>Terminals (100% matte Sn)</td> </tr> <tr> <td>4</td> <td>Protection Coating (Epoxy resin)</td> </tr> </tbody> </table>	Number	Description	1	Substrate (glass epoxy)	2	Resistor Element (Cu alloy foil)	3	Terminals (100% matte Sn)	4	Protection Coating (Epoxy resin)
Number	Description										
1	Substrate (glass epoxy)										
2	Resistor Element (Cu alloy foil)										
3	Terminals (100% matte Sn)										
4	Protection Coating (Epoxy resin)										

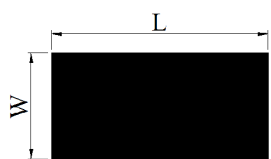
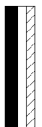
Product Dimensions:

<p style="text-align: center;"><u>Top</u></p> 	<p style="text-align: center;"><u>Side</u></p> 	<p style="text-align: center;"><u>Bottom</u></p> 	<p style="text-align: center;"><u>Side</u></p> 	
All dimensions shown in inches, mm in parenthesis.				
Dimensions (Metric)	L	W	A	T
D1LPC0201 (0603)	0.024 ±0.001 (0.60 ±0.03)	0.012 ±0.002 (0.30 ±0.04)	0.010 ±0.004 (0.25 ±0.10)	0.006 ±0.002 (0.15 ±0.06)
D1LPC0402 (1005)	0.040 ±0.008 (1.00 ±0.20)	0.020 ±0.008 (0.50 ±0.20)	0.008 ±0.006 (0.20 ±0.15)	0.012 ±0.006 (0.30 ±0.15)
D1LPC0603 (1608)	0.063 ±0.008 (1.60 ±0.20)	0.031 ±0.008 (0.80 ±0.20)	0.014 ±0.008 (0.35 ±0.20)	0.014 ±0.008 (0.35 ±0.20)
D1LPC0805 (2012)	0.078 ±0.008 (2.00 ±0.20)	0.049 ±0.008 (1.25 ±0.20)	0.014 ±0.008 (0.35 ±0.20)	0.016 ±0.008 (0.40 ±0.20)
D1LPC1206 (3216)	0.126 ±0.008 (3.20 ±0.20)	0.063 ±0.008 (1.60 ±0.20)	0.020 ±0.008 (0.50 ±0.20)	0.016 ±0.008 (0.40 ±0.20)

Part Numbering: Ex: D1LPC0402CJUMPF-T10

Series Name	English Size (Metric Size)	Resistive Element	Resistance Value	Internal Code	T&R Packaging Quantity
D1LPC	0201 (0603) 0402 (1005) 0603 (1608) 0805 (2012) 1206 (3216)	C = Cu Alloy	JUMP = Jumper, 0Ω	F = Face Down	-T10 = 10,000 pcs/reel -T5 = 5,000 pcs/reel

Electrical Specifications:

Type	LPC0201	LPC0402	LPC0603	LPC0805	LPC1206
Metric Size	0603	1005	1608	2012	3216
Max Current	8 Amps	20 Amps	26 Amps	35 Amps	40 Amps
Resistance Values	1mΩ Max	0.5mΩ Max	0.2mΩ Max		
Operating Temp. Range	-55°C~+155°C		-55°C~+170°C		
Packaging (code)	10,000 pcs/reel (-T10)		5,000 pcs/reel (-T5)		

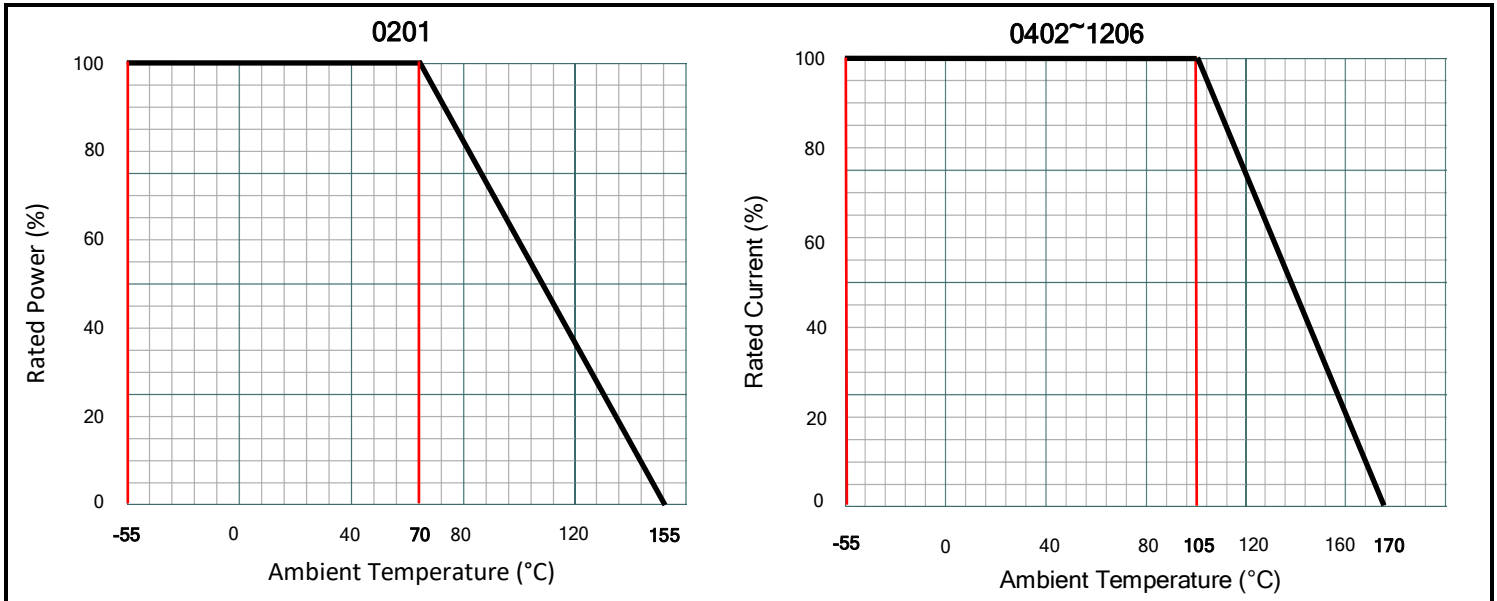
Power Derating Curves:**Reliability Specifications:**

Test	Test Method	Specification
Resistance Data	Resistance data at 25°C	Must meet datasheet requirements
TCR Data	Tested at 25°C and 125°C $TCR = (R_b - R_a) / R_a \times 1 / (T_b - T_a) \times 10^6$	Must meet datasheet requirements
Dimensional Data	Measure all dimensions specified in datasheet	Must meet datasheet requirements
Short Time Overload JIS-C-5201, 4.13	Applied voltage: 2.5X rated voltage. Test duration: 5 seconds	±1.0%
Load Life, Power Cycling (1) JIS-C-5201-1, 4.25	Test Temperature: 70°C Applied voltage: rated power Test period: 1,000 hours with power cycling as follows: 90 min. power ON/30 min. power OFF,	±1.0%
Temperature / Humidity (1) JIS-C-5201-1, 4.24	Test Condition: 60°C / 90-95% RH Test period: 1,000 hours	±1.0%
Temperature Cycle (1) (Thermal Shock) JESD22-A-104	Repeat 1,000 cycles as follows: -55°C (30 min.) / +125°C (30 min.) Transition time of 1 minute maximum	±1.0%
Resistance To Solder Heat #1 J-STD-020	One reflow cycle according to JEDEC J-STD-020, cool down then parts are immersed into a molten solder bath with a temperature of 260°C for a period of 10 ±1 seconds.	Part must meet initial specifications following testing.
Resistance To Solder Heat #2 J-STD-020	Per component MSL classification per J-STD-020 3 reflow cycles	±1.0%
Load Life, Endurance (1) MIL-STD-202, Method 108, Condition D	Test Temperature: 70°C Test period: 1,000 hours Electrical load: rated power	±1.0%

Notes:

(1) Samples shall be from the pre-conditioned group

Reliability Specifications (Cont.):

Test	Test Method	Specification
HAST (1) (Highly Accelerated Stress Test - Autoclave)	Test Temperature: 121°C Test Pressure: 30 PSIA Test period: 48 hours No electrical load	±1.0%
Biased Humidity MIL-STD-202, Method 103	Test Temperature: 60°C / 90-95% RH Test period: 1,000 hours Electrical load: 10% of rated power	±1.0%
Terminal Strength AEC-Q200-006	Test Force: 17.7N Duration: 60 ±1 seconds Parts must be soldered onto a PCB to perform test	±0.5%
Flex Strength	Board Flex: Span 90mm, Flex of 2mm Test Duration: 10 seconds	±1.0%
Vibration (1) MIL-STD-202, Method 204, Condition B	Frequency: 10 - 2,000Hz Acceleration: 15G Test Duration: 20 mins / 12 Cycles	±1.0%
Mechanical Shock (1) MIL-STD-202, Method 213, Condition A	Force: 50G Test Duration: 11 ±1 milliseconds	±1.0%
Solderability MIL-STD-202, Method 208H, Category 3	Dipped into molten solder for 3 ±1 seconds at 245°C Flux activity type R0	New solder coverage of 90% minimum
Pre-Conditioning	Per component MSL classification per J-STD-020 3 reflow cycles	N/A

Notes:

(1) Samples shall be from the pre-conditioned group

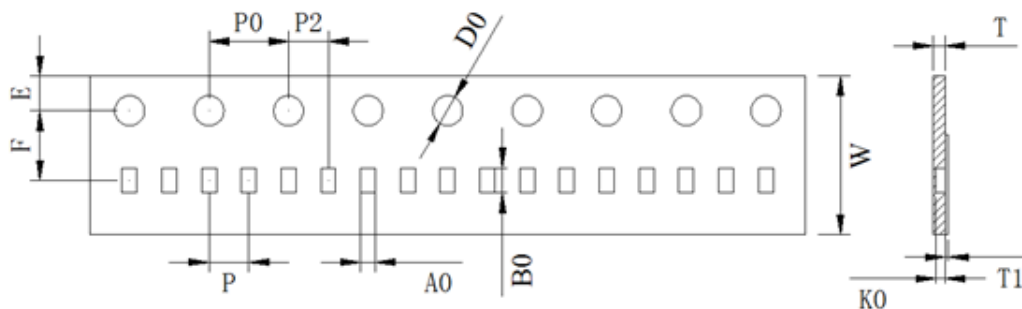
Paper Tape Dimensions:

All dimensions in mm.

Size	W	P0	P	P2	A0	B0	D0	F	E	T	T1	K0
0201	8.00 ±0.20	4.00 ±0.10	2.00 ±0.10	2.00 ±0.10	0.38 ±0.10	0.68 ±0.10	1.50 ±0.10	3.50 ±0.10	1.75 ±0.10	0.45 ±0.05	Max 0.10	0.30 ±0.05
0402	8.00 ±0.30	4.00 ±0.10	2.00 ±0.10	2.00 ±0.10	0.65 ±0.10	1.10 ±0.10	1.50 ±0.10	3.50 ±0.10	1.75 ±0.10	0.42 ±0.05	-	-
0603	8.00 ±0.30	4.00 ±0.10	4.00 ±0.10	2.00 ±0.10	0.98 ±0.10	1.85 ±0.10	1.50 ±0.10	3.50 ±0.10	1.75 ±0.10	0.60 ±0.05	-	-
0805	8.00 ±0.30	4.00 ±0.10	4.00 ±0.10	2.00 ±0.10	1.55 ±0.10	2.30 ±0.10	1.50 ±0.10	3.50 ±0.10	1.75 ±0.10	0.60 ±0.10	-	-
1206	8.00 ±0.30	4.00 ±0.10	4.00 ±0.10	2.00 ±0.10	2.05 ±0.20	3.65 ±0.20	1.50 ±0.10	3.50 ±0.10	1.75 ±0.10	0.60 ±0.10	-	-

Reel Dimensions:

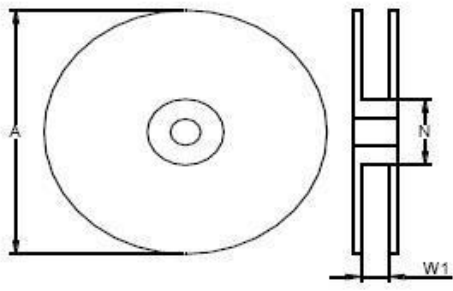
 <p>All dimensions in mm.</p>	Size	Quantity	A	N	W1
	0201	10,000 pcs/reel	178 ±5.00	60.0 ±2.00	9.00 ±1.00
	0402				
	0603	5,000 pcs/reel			
	0805				
1206					

Recommended Land Pattern:

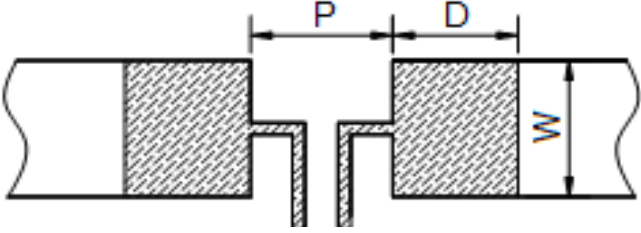
 <p>All dimensions in mm.</p>	Size	P	W	D
	0201	0.25	0.33	0.20
	0402	0.40	0.60	0.60
	0603	0.60	0.92	1.30
	0805	0.80	1.44	1.40
1206	1.20	1.84	1.80	

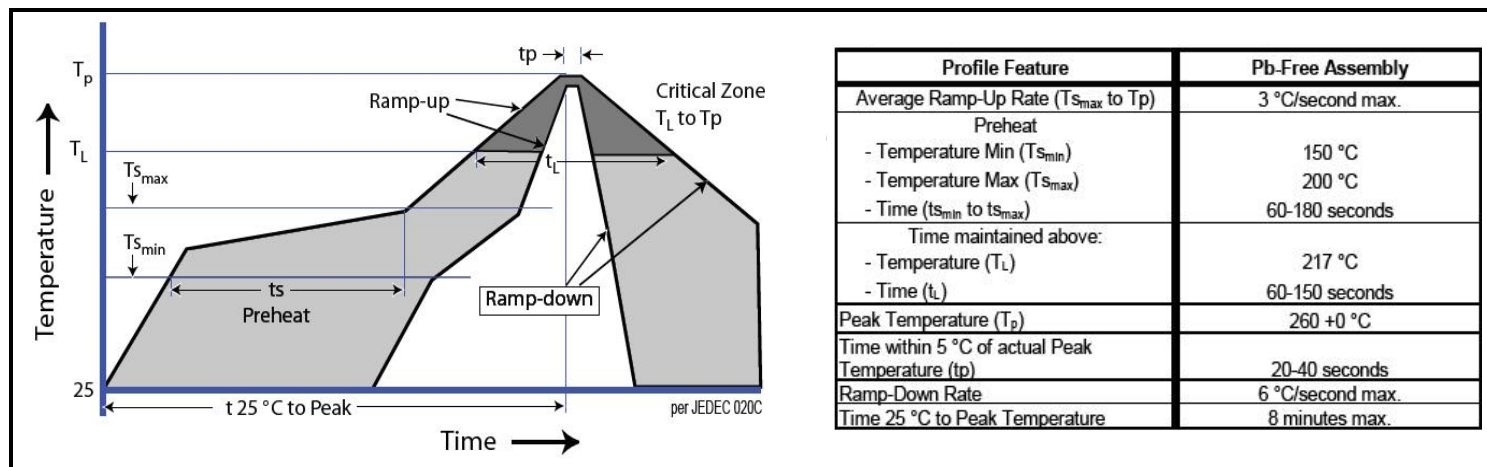
Soldering Profile:**Storage Conditions:****Environment Conditions:**

Products should be stored under the following environmental conditions.

- Temperature: +5 to +35°C
- Humidity: 45 to 85% relative humidity
- Do not keep products in environments where they may be subject to particulate contamination or harmful gases such as sulfuric acid or hydrogen chloride as it may cause oxidization on electrodes, resulting in poor solderability.
- Products should be stored in a space that does not expose it to high temperatures, vibration, or direct sunlight.
- Products should be stored in the original airtight packaging until use.